



Version  
03.00

July  
2007

## R&S® CBT/CBT32 Bluetooth® Testers

Fast and comprehensive RF and audio measurements for development, production, and verification

- ◆ Highly flexible troubleshooting in R&D
- ◆ Very short measurement times for high throughput in production
- ◆ Integrated spectrum measurements
- ◆ R&S® CBTGo software supporting 18 Bluetooth® RF test cases
- ◆ Bluetooth® audio profiles (handsfree, headset, and A2DP profiles)
- ◆ Dual-channel audio generator and analyzer



**ROHDE & SCHWARZ**

## At a glance

The R&S® CBT Bluetooth® testers perform Bluetooth® RF tests on all channels in hopping or non-hopping mode. They offer a large number of statistical monitoring and measurement functions. It is possible, for instance, to define tolerances for each measured value, or to stop a measurement sequence after a certain number of measurements or when a tolerance has been exceeded. In addition to the common traces for power, modulation, and spectrum, averaged minimum or maximum traces can be displayed over a user-defined number of packets.

The V2.0+EDR and V2.1+EDR Bluetooth® standards distinguish between basic rate and enhanced data rate (EDR) packets. Basic rate packets are already known from the V1.1 and V1.2 standards. EDR packets use the same packet header as basic rate packets (GFSK modulation) but transmit the payload using DPSK modulation ( $\pi/4$ -DQPSK or 8DPSK). The Bluetooth® transmitter must therefore be able to switch over from GFSK to DPSK modulation within 5  $\mu$ s. The DPSK modulation of the EDR packets yields a data transmission rate up to three times as high as that of basic rate packets. The Bluetooth® technology thus opens up new applications, e.g. the uncompressed transmission of CD audio signals. For all applications that do not require higher data rates, EDR packets lead to smaller

packet lengths. This reduces power consumption, which is particularly important for battery-powered devices (e.g. Bluetooth® headsets). The Bluetooth® RF test specification (V1.2/V2.0/V2.0+EDR/V2.1/V2.1+EDR) includes several test cases for EDR DUTs.

The R&S® CBT-K55 EDR option adds a large number of EDR RF tests to the R&S® CBT Bluetooth® testers.

## R&S® CBT – the most versatile Bluetooth® tester for troubleshooting in the lab

Using the R&S® CBT, you can carry out a variety of spectrum measurements on an active Bluetooth® connection

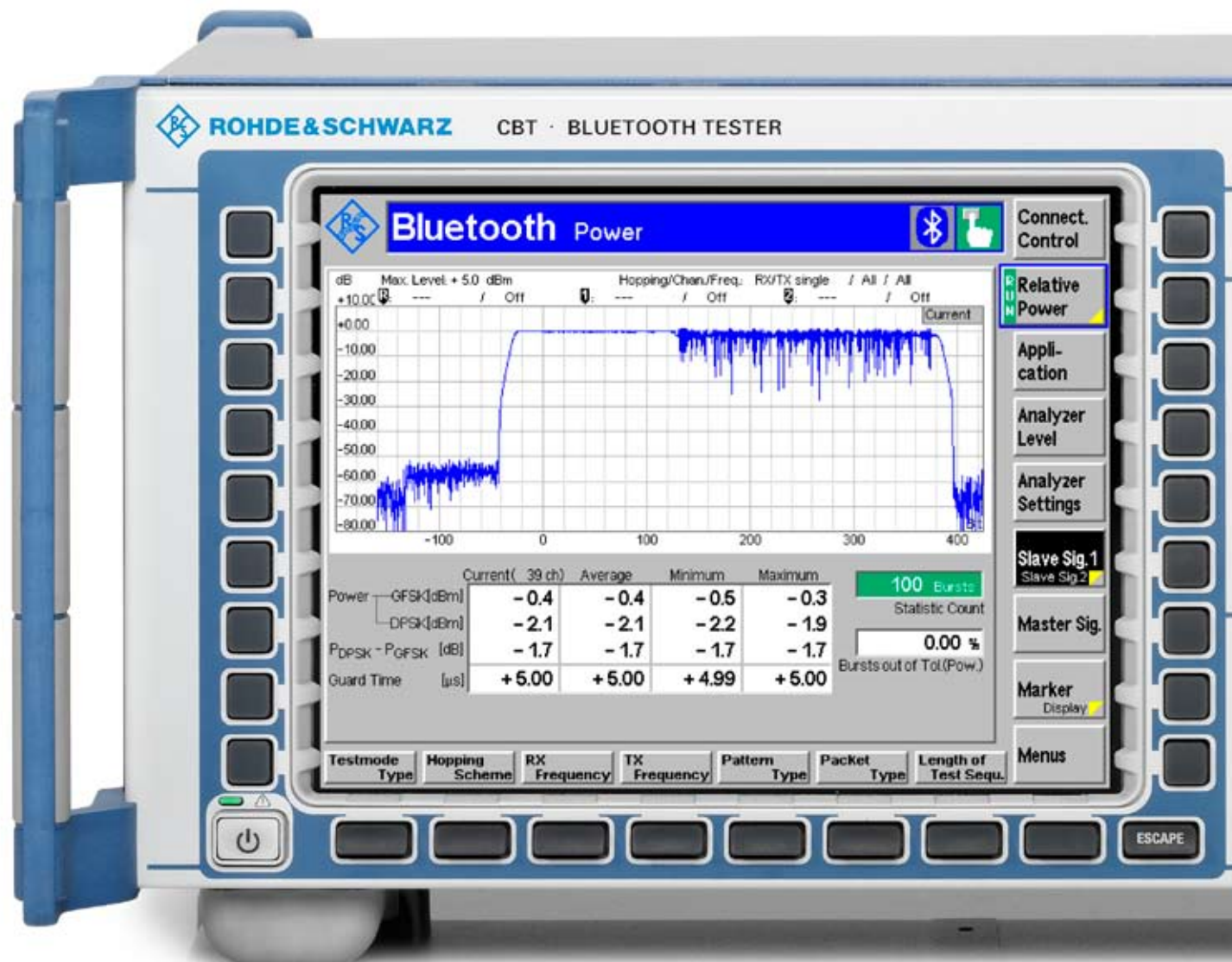

without requiring any extra spectrum analyzers. The R&S® CBT's high versatility results from the use of a parametric measurement concept, which allows all Bluetooth® signal parameters to be set in virtually any desired combination. The effect of different parameter combinations on results can be seen immediately. For example, most measurements can be performed on single frequencies or in hopping mode using any desired bit patterns and packet types.

Traces are output virtually in realtime on the R&S® CBT's large graphical display. They can be analyzed in detail with the aid of switchable markers. Measurement parameters, e.g. level and frequency,

and other settings, e.g. marker positions, can conveniently be varied using the rotary knob. Power control is available in all TX measurement menus. It is thus easy to measure modulation or spectral characteristics at different transmit powers.

### R&S® CBT – the record holder in speed for Bluetooth® tests in production

The R&S® CBT uses parallel signal processing, and therefore performs Bluetooth® tests in production lines at extremely high speed. While conventional Bluetooth® testers sequentially measure power, modulation, frequency

accuracy, and finally frequency drift, the R&S® CBT performs all these measurements in a single test cycle, thus offering unparalleled speed for Bluetooth® TX measurements. The highly flexible remote-control programming makes it easy to adapt measurement configurations to any specific test requirements, and measurements are then performed at maximum possible speed. For example, if measurements are to be carried out on five channels instead of the three channels used by conventional testers, the R&S® CBT remote-control program can easily be modified to include two more channels. In the case of other testers, this would require running the entire test sequence a second time, which would considerably slow down the measurement process.

### R&S® CBT and R&S® CBT32 – the perfect combination for R & D and production

Featuring a wide range of control options and a large display, the R&S® CBT is the ideal choice for R & D applications in the lab. When a product is to be transferred to production, the remote-control program for the tester can first be created conveniently on the R&S® CBT, which allows every test step to be verified in manual operation. Later, in the production line, the more favorably priced R&S® CBT32 can be used. The R&S® CBT32 is intended exclusively for remote control and optimized for integration into 19" racks. The R&S® CBT and the R&S® CBT32 have identical hardware and software, the main difference being that the R&S® CBT32 has no control elements.



*R&S® CBT Bluetooth® tester with large display for R & D and production*

## Signaling

### Setting up a Bluetooth® connection

The R&S® CBT acts as a master in a Bluetooth® piconet, the DUT as a slave. The R&S® CBT can perform the inquiry procedure for the identification of all Bluetooth® devices within range of the R&S® CBT. All devices found are displayed, and one of them can be selected for the paging procedure. The R&S® CBT then sets up a connection to the DUT and switches it to the test mode. The inquiry procedure can be skipped if the Bluetooth® device address of the DUT is known. In this case, the time required for connection setup is reduced. This is an important aspect for production tests on Bluetooth® devices, as it helps to increase throughput on the production line. The Bluetooth® test mode specification stipulates that the DUT has to be locally enabled for the test mode. After a Bluetooth® link is established, the R&S® CBT sends commands to the DUT to switch it to the desired test mode. In the test mode, the R&S® CBT can perform a number of transmitter and receiver measurements. The R&S® CBT is also capable of setting up a normal Bluetooth® asynchronous connectionless (ACL) link without activating the test mode. Via this link, the power and frequency accuracy of every DUT can be measured, regardless of whether the DUT has been locally enabled for the test mode. Via the ACL link, the tester can also estimate the receiver sensitivity by determining the percentage of packets for which no response is received from the DUT.

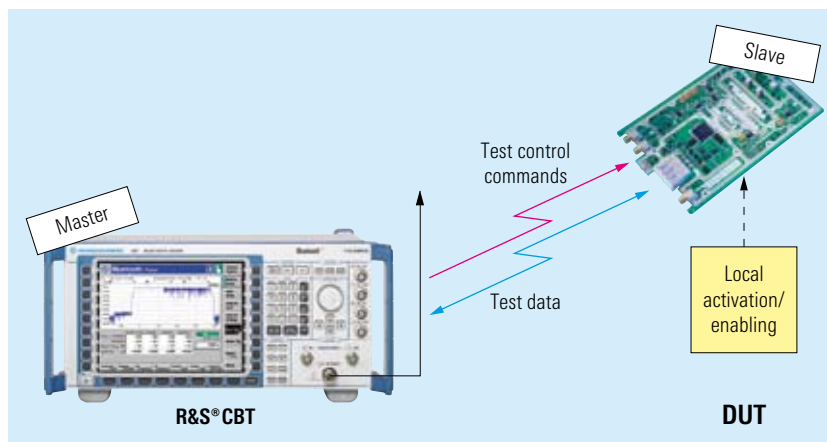

*The R&S® CBT controls the DUT in the test mode via test control commands*

### Information signaled by the DUT

The R&S® CBT can display a variety of information received from the DUT (e.g. device name, version numbers, service class, supported features).

### Park, hold, and sniff modes

The power consumption of a Bluetooth® chipset is considerably reduced in these modes, which therefore play an important role in all battery-powered Bluetooth® devices. The R&S® CBT can switch the DUT to the park, hold, or sniff mode, and the DUT power consumption can be checked by means of external test equipment.

### Audio mode

In the audio mode, the R&S® CBT establishes a synchronous connection-oriented (SCO) link to the DUT in addition to the ACL link. The R&S® CBT's built-in Bluetooth® audio codec supports CVSD as well as A-law and  $\mu$ -law coding. External audio generators and analyzers can be connected by means of an analog input and an analog output on the R&S® CBT front panel. The described functionality is provided as standard by the R&S® CBT and R&S® CBT32 base units.

### Audio options

The following audio options are available for both the R&S® CBT and the R&S® CBT32 to enable extensive audio testing of Bluetooth® devices:

- ◆ Dual-channel audio generator and analyzer (R&S® CBT-B41)
- ◆ Digital audio interface (R&S® CBT-B42)
- ◆ Support of handsfree and headset profiles (R&S® CBT-K54)
- ◆ Support of A2DP stereo profile (R&S® CBT-K52)



## R&S®CBT-B41 dual-channel audio generator and analyzer

The R&S®CBT-B41 hardware option includes two audio generators and two audio analyzers for measuring the audio characteristics of Bluetooth® DUTs. The option adds four more connectors to the R&S®CBT front panel: two output sockets for the audio generators and two input sockets for the audio analyzers. The audio signals are routed via internal audio switches either to the connectors for external equipment or to the internal Bluetooth® speech codec. Various test scenarios can be implemented:

### Microphone test

The DUT microphone, audio input amplifier, and A/D converter are tested. The R&S®CBT generates an audio signal, which is applied to the DUT microphone via a reference loudspeaker. The DUT returns the audio signal to the R&S®CBT via the Bluetooth® link, and the R&S®CBT audio analyzer measures the signal.

### Loudspeaker/ear piece test

The DUT D/A converter, output amplifier, and loudspeaker/ear piece are tested. The R&S®CBT generates an audio signal and sends it to the DUT via

the Bluetooth® link. The DUT outputs the audio signal via its sound converter. The signal is picked up by a reference microphone and taken via a reference amplifier to the R&S®CBT, where audio analysis is performed.

## Audio measurements

The R&S®CBT-B41 option enables high-speed frequency response measurements in multitone mode. The user can define up to 20 tones in terms of level and frequency for each of the two audio channels.

In single-tone mode, the following measurements can be performed: audio level (RMS, peak), DC level, frequency, SINAD, THD+N (total harmonic distortion + noise). A THD measurement function is available in addition, which outputs the fundamental plus eight harmonics in the form of a bargraph.

Various filters are available for audio measurements:

- ◆ 19 fixed-frequency bandpass filters
- ◆ One variable bandpass filter (20 Hz to 20 kHz, bandwidth selectable from 10 Hz to 1000 Hz)
- ◆ Weighting filters (A, CCITT, C-message)

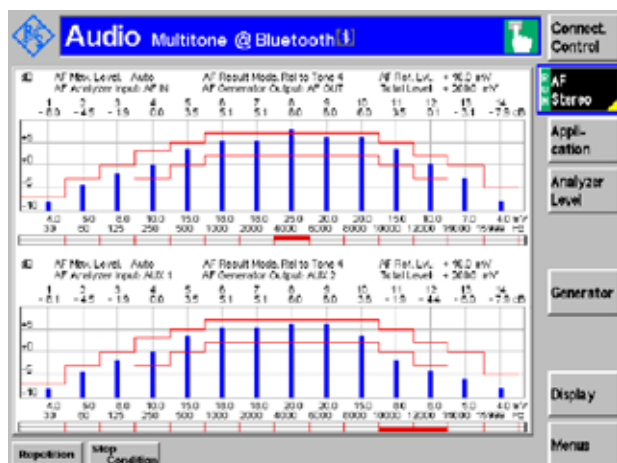

*Fast frequency response measurement of stereo signals with the R&S®CBT-B41 option in multitone mode*

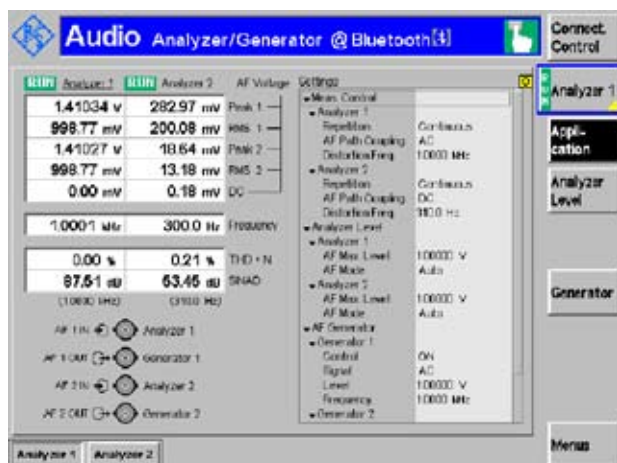

*Measurement menu of the R&S®CBT-B41 option in single-tone mode*

## R&S®CBT-B42 digital audio interface

The R&S®CBT-B42 hardware option expands the R&S®CBT by a digital audio interface consisting of an input and an output in line with the S/P-DIF specification. The direct input of digital audio signals avoids any distortion caused by D/A and A/D conversion in signal transmission. For this option, the R&S®CBT-B41 audio generator and analyzer option must be installed.

### R&S® CBT-K54 handsfree and headset profiles

To perform audio measurements on any type of Bluetooth® handsfree or headset equipment, the R&S® CBT must support the handsfree and headset profiles. This capability is provided by the R&S® CBT-K54 software option, which also allows links to be set up to the corresponding audio gateways (mobile phones, laptops).

### R&S® CBT-K52 A2DP stereo profile and SBC codec

The R&S® CBT-K52 software option has been designed for audio tests on Bluetooth® stereo DUTs (e.g. headsets). The option supports the SBC stereo codec. This codec is mandatory for all Bluetooth® devices using the A2DP profile, and the R&S® CBT is thus able to perform stereo audio tests on all DUTs employing this profile. For the R&S® CBT-K52 option, the R&S® CBT-B41 audio generator and analyzer option must be installed, as it provides a total of four audio connectors for the input and output of the analog stereo signals.

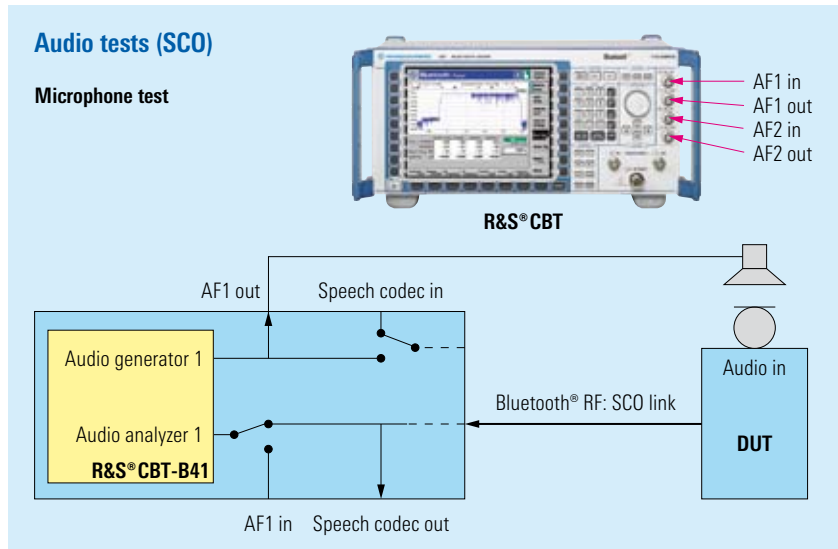

Audio measurement of a DUT microphone with the R&S® CBT-B41 option

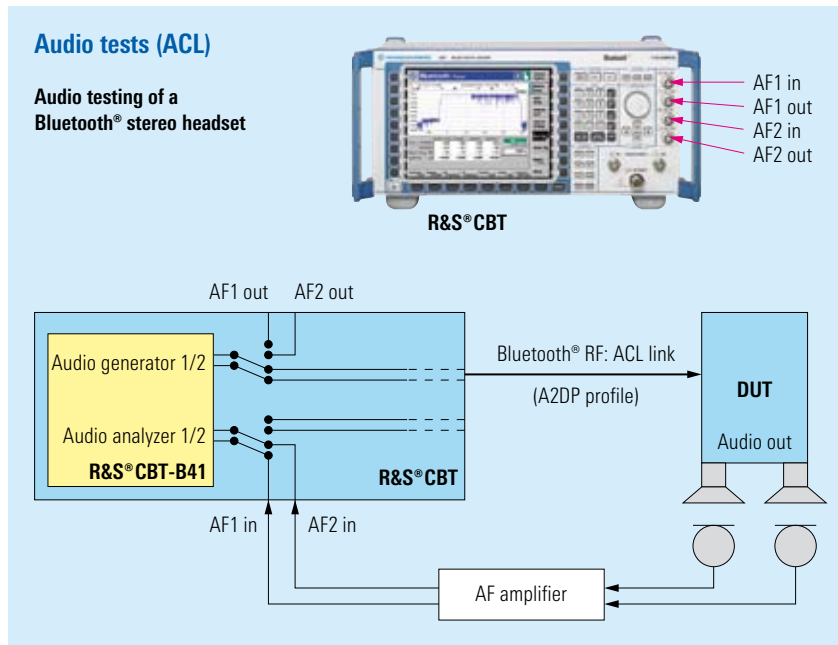

Audio measurement of a stereo headset using the A2DP profile

## Power measurements (TX)

The current measurement values for each parameter are displayed on the R&S® CBT screen. In addition, average, maximum, and minimum values are displayed as a result of a statistical evaluation of a settable number of Bluetooth® packets (bursts).

### Output power

Measurement parameters:

- ◆ Nominal power:  
Average power from bit 0 to the last bit of the burst
- ◆ Peak power:  
Highest power level within the entire burst including the power ramps
- ◆ Leakage power:  
Average power across two measurement windows before and after the burst; the position and length of each window can be defined

### Relative power

To determine the power of EDR packets, the R&S® CBT measures the average power within the GFSK portion as well as within the DPSK portion of an EDR packet and calculates the power difference.

Measurement parameters:

- ◆  $P_{\text{GFSK}}$  (measured from bit 0 to the last bit of the packet header)
- ◆  $P_{\text{DPSK}}$  (measured from the first bit of the synchronization sequence to the last bit of the packet, excluding trailer bits)
- ◆  $P_{\text{DPSK}} - P_{\text{GFSK}}$  (difference should be between -4 dB and +1 dB)

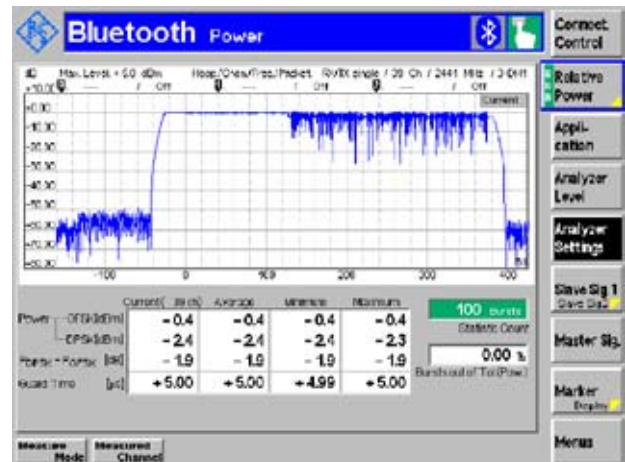

Power and guard time measurement of an EDR packet

### Power control

The R&S® CBT can send "Power up" and "Power down" commands to the DUT. Two keys are available for manual power control. After each keystroke, the R&S® CBT displays the difference power level with respect to the previous level. The Bluetooth® specifications stipulate that all difference values should be in the 2 dB to 8 dB range. When the maximum or minimum power level is reached, the DUT sends a message, which is displayed on the R&S® CBT.

An outstanding feature of the R&S® CBT is that power control functionality is available also for all frequency, modulation, and spectrum measurements.

## Timing measurements (TX)

Measurement parameters:

- ◆ Packet timing:  
Time difference between ideal master receiver slot and detected bit 0 of the received burst. This measurement is displayed on the Output Power screen
- ◆ Guard time (EDR):  
Time interval between the end of the last GFSK symbol of the packet header and the beginning of the reference symbol of the synchronization sequence. This measurement is displayed on the Relative Power screen

## Modulation and frequency measurements (TX)

### Measurement of basic rate packets

Measurement parameters:

- ◆ Frequency accuracy/initial carrier frequency tolerance (ICFT):  
Difference between the measured transmit frequency and the expected transmit frequency, measured in the preamble at the beginning of each packet
- ◆ Carrier frequency drift:  
Difference between the frequency at the start of a packet and the frequency in the payload
- ◆ Maximum drift rate:  
Maximum drift rate, anywhere within the packet payload
- ◆ Frequency deviation:  
Average, maximum, and minimum frequency deviation within the packet payload

In compliance with the Bluetooth® RF test specification, a minimum of 99.9% of all measured bits must have a frequency deviation of at least 115 kHz. The R&S® CBT shows the measured percentage in a dedicated field (Bits Above Threshold) in the GFSK modulation menu. The 115 kHz threshold value can be varied as required.

### EDR carrier stability and modulation accuracy

To perform these measurements, a Bluetooth® packet is first divided into the GFSK portion (packet header) and multiple blocks, each containing 50 symbols of the DPSK portion (payload).

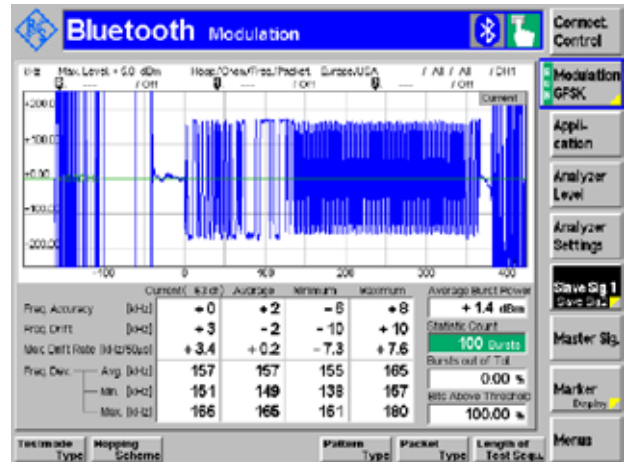

Modulation, frequency, and drift measurement of a basic rate packet



Frequency stability and modulation accuracy measurement of an EDR packet

Measurement parameters:

- ◆ Carrier frequency stability ( $\omega_1$ ):  
The R&S® CBT determines the average frequency within the GFSK portion of a packet. The result  $\omega_1$  is the difference between the average frequency and the expected frequency
- ◆ Carrier frequency stability ( $\omega_{0max}$ ):  
The R&S® CBT determines the average frequency for each block of the DPSK portion relative to the average frequency within the GFSK portion, i.e. the result  $\omega_0$  is the difference in each case. The largest measured  $\omega_0$  value is displayed
- ◆ RMS DEVM:  
The R&S® CBT measures the differential error vector magnitude (DEVM) for each of the 50 symbols of a block. It then calculates the RMS DEVM value for each block and displays the largest value
- ◆ Peak DEVM:  
The R&S® CBT determines the peak DEVM value by analyzing all symbols of all blocks
- ◆ 99% DEVM:  
The R&S® CBT displays the percentage of measured symbols whose DEVM value is at or below an adjustable threshold



### EDR differential phase encoding

This measurement checks whether the EDR encoder in the DUT is functioning properly. This is done by means of a BER measurement in the TX test mode. The DUT sends a predefined bit sequence to the R&S® CBT, which compares the received bits with the expected bits.

Measurement parameters:

- ◆ BER (percentage of bit errors that have occurred within the current statistical cycle)
- ◆ Percentage of packets with 0 bit errors within the current statistical cycle

### EDR I/Q constellation diagram and phase difference characteristic

The I/Q constellation diagram displays EDR packets in the I/Q plane. Bluetooth® EDR packets use differential modulation (DPSK); the I/Q diagram in the absolute symbol mode therefore does not provide any information as to the decodability of the signal. For this reason, the R&S® CBT also offers a differential display in the I/Q plane (differential symbol mode), where the preceding symbol is used as a reference in each case. This enables assessment of the signal quality.

The phase difference characteristic shows the phase difference of each symbol relative to the preceding symbol as a function of time. The phase difference characteristic contains the bit information of each symbol and thus allows the individual symbols to be decoded. Using this characteristic, it is also possible to check the DPSK synchronization sequence.

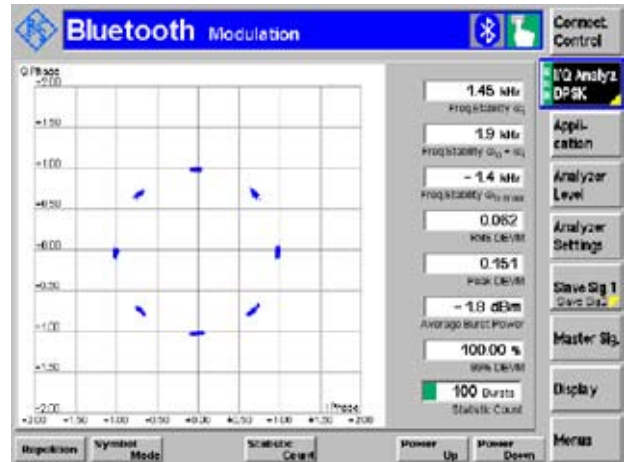

Constellation diagram of an EDR packet in differential symbol mode

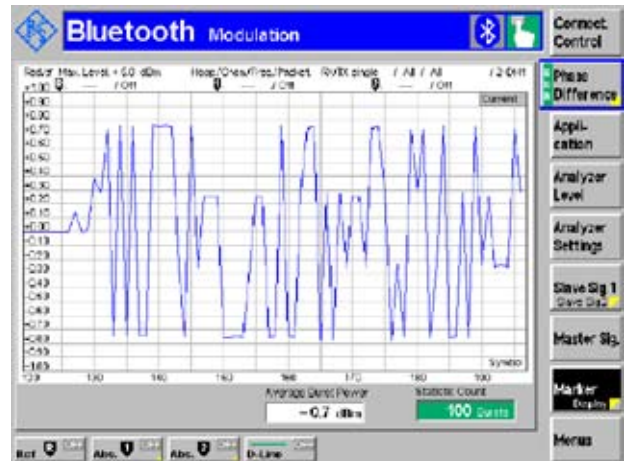

Phase difference characteristic of an EDR packet

## Spectrum measurements (TX)

### 20 dB bandwidth

The graphic display in the 20 dB bandwidth measurement menu shows the frequency spectrum of the measured Bluetooth® channel. This spectrum measurement can be performed in hopping mode in addition to fixed frequencies.

Measurement parameters:

- ◆  $f_L$ :  
Lowest frequency at which the power level drops to 20 dB below the peak power of the measurement channel
- ◆  $f_H$ :  
Highest frequency at which the power level drops to 20 dB below the peak power of the measurement channel
- ◆  $f_H - f_L$ :  
Difference between the two values (should be smaller than 1 MHz)

The 20 dB reference value can be varied as required. The R&S® CBT shows the results for the Current, Average, and Maximum display modes.

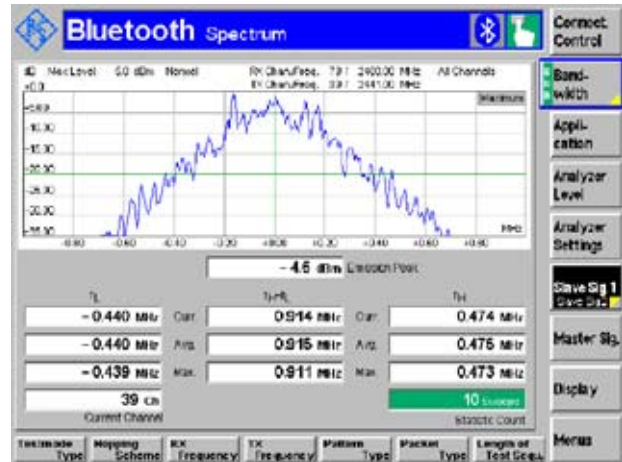

20 dB bandwidth measurement

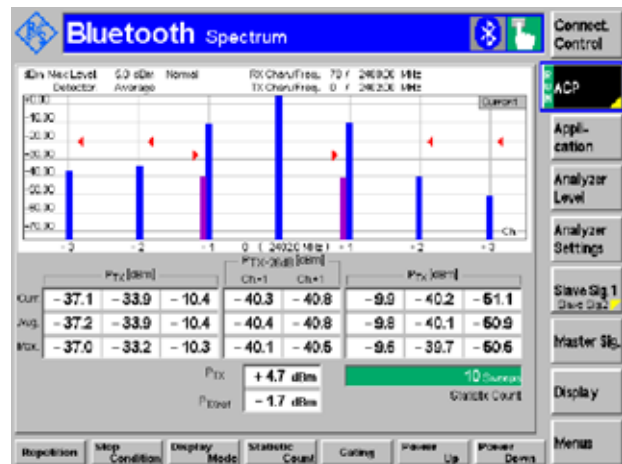

EDR in-band spurious emissions measurement

### Frequency range

The graphic display in the frequency range measurement menu shows the spectral characteristic of the measured Bluetooth® signal at the upper and the lower end of the Bluetooth® frequency band.

Measurement parameters:

- ◆  $f_L$ :  
Lowest frequency at which the power level drops to -30 dBm
- ◆  $f_H$ :  
Highest frequency at which the power level drops to -30 dBm

The -30 dBm limit on the R&S® CBT corresponds to a spectral power density of -80 dBm/Hz EIRP.

### Adjacent channel power (ACP)

The ACP measurement menu shows the absolute power of a center channel as well as of three upper and three lower channels. All channels are user-selectable. The R&S® CBT performs ACP measurements in compliance with the Bluetooth® RF test specification. The tester starts outputting results for all seven channels after less than a second, which considerably reduces test time in the lab as compared with the use of conventional spectrum analyzers.

### EDR in-band spurious emissions (gated ACP)

The ACP measurement menu includes a gating function that enables switch-over between normal and gated ACP measurements. The high flexibility of the R&S® CBT allows you to perform normal as well as gated ACP measurements on both basic rate and EDR packets.

In the gating mode, the R&S® CBT additionally displays the  $P_{TXref}$  and  $P_{TX-26dB}$  results stipulated by the Bluetooth® RF test specification.

## Special features

### Channel display in frequency-hopping mode

With the R&S® CBT, you can conveniently determine all RF channels in which the DUT exceeds specified tolerances. If On Limit Failure is set as a stop condition in frequency-hopping measurements, the R&S® CBT automatically stops when a measured value exceeds a definable limit. The R&S® CBT also displays the number of the channel in which the out-of-tolerance condition has occurred – a very helpful function for laboratory measurements.

### Measurements without link setup

Many Bluetooth® DUTs can be locally switched to the TX test mode via the HCI interface. The R&S® CBT can then carry out power, frequency, and modulation measurements on the DUT without requiring a Bluetooth® link.

## RX measurements

For RX measurements, the tester's built-in signal generator delivers a selectable bit sequence, which is sent to the DUT, looped back, and demodulated and processed by the R&S® CBT. The TX level of the R&S® CBT can be adjusted. When the EDR option is added, the receiver quality measurement menu offers EDR packet types (2-DH1, 2-DH3, and 2-DH5 as well as 3-DH1, 3-DH3, and 3-DH5) in addition to the basic rate packet types (DH1, DH3, DH5).

### BER/PER tests

Measurement parameters:

- ◆ Bit error rate (BER):  
Percentage of errored bits returned by the DUT
- ◆ Bit errors:  
Number of errored bits returned by the DUT
- ◆ NAK rate:  
Percentage of packets returned by the DUT with a negative acknowledgment (NAK). The DUT returns a packet with a NAK if it contains at least one bit error
- ◆ Packet error rate (PER):  
Percentage of errored packets returned by the DUT. The R&S® CBT ignores errored packets in the BER calculation

The PER result is broken down according to the following five criteria:

- ◆ Missing packets:  
Percentage of packets not returned by the DUT
- ◆ HEC error:  
Percentage of returned packets containing non-correctable bit errors in the header
- ◆ CRC error:  
Percentage of returned packets containing at least one error in the payload. These errors are bit errors that occur during retransmission of the packet
- ◆ Wrong packet type:  
Percentage of returned packets with incorrect packet type. These are usually null packets
- ◆ Wrong payload length:  
Percentage of packets returned with incorrect payload length

The R&S® CBT offers a BER search function that automatically determines the DUT sensitivity level for a predefined BER level.

### Dirty transmitter

For BER tests, the Bluetooth® RF test specification stipulates a dirty transmitter (dirty TX) as a signal source in the tester.

### Dirty transmitter for basic rate packets

Every 20 ms, the dirty TX changes the frequency offset, modulation index, and symbol timing error. A table in the specification lists ten different value combinations of these three parameters, which are used one after the other. The dirty TX additionally superimposes a defined frequency drift on its output signal; the frequency drift phase varies by 180° from packet to packet.

### Dirty transmitter for EDR packets

Every 20 packets, the dirty TX changes the frequency offset and symbol timing error. A table in the specification lists three different value combinations of these two parameters, which are used one after the other. The dirty TX additionally superimposes a defined frequency drift on its output signal; the frequency drift phase varies by 180° from packet to packet.

The dirty TX in the R&S® CBT and R&S® CBT32 can be operated in the following modes:

- ◆ Dynamic dirty TX using the value table from the specification; drift superposition switched on
- ◆ Dynamic dirty TX using a user-defined value table; drift superposition switched on or off
- ◆ Static dirty TX; the values for frequency offset, modulation index, and symbol timing error can be set in any combination with one another; drift superposition switched on or off

## Bluetooth® RF test cases

The R&S®CBT and R&S®CBT32 can be used for evaluating the following Bluetooth® test purposes as described in the V1.2/V2.0/V2.0+EDR/V2.1/V2.1+EDR Bluetooth® RF test specification:

- ◆ TRM/CA/01/C (Output Power)
- ◆ TRM/CA/03/C (Power Control)
- ◆ TRM/CA/04/C (TX Output Spectrum – Frequency Range)
- ◆ TRM/CA/05/C (TX Output Spectrum – 20 dB Bandwidth)
- ◆ TRM/CA/06/C (TX Output Spectrum – Adjacent Channel Power)
- ◆ TRM/CA/07/C (Modulation Characteristics)
- ◆ TRM/CA/08/C (Initial Carrier Frequency Tolerance)
- ◆ TRM/CA/09/C (Carrier Frequency Drift)
- ◆ TRM/CA/10/C (EDR Relative Transmit Power)
- ◆ TRM/CA/11/C (EDR Carrier Frequency Stability and Modulation Accuracy)
- ◆ TRM/CA/12/C (EDR Differential Phase Encoding)
- ◆ TRM/CA/13/C (EDR In-Band Spurious Emissions)
- ◆ RCV/CA/01/C (Sensitivity – Single-Slot Packets)
- ◆ RCV/CA/02/C (Sensitivity – Multi-Slot Packets)
- ◆ RCV/CA/06/C (Maximum Input Level)
- ◆ RCV/CA/07/C (EDR Sensitivity)
- ◆ RCV/CA/08/C (EDR BER Floor Performance)
- ◆ RCV/CA/10/C (EDR Maximum Input Level)

*The R&S®CBTGo software generates measurement reports at the press of a button*

## R&S®CBTGo software for automatic testing

R&S®CBTGo is a PC application software package for remote control of the R&S®CBT and R&S®CBT32. The software can be downloaded free-of-charge from the Rohde & Schwarz website. Using R&S®CBTGo, you can conveniently create any desired test sequences by configuring and combining selectable test modules. The software generates measurement reports at the press of a button. Reports can be stored in various formats. R&S®CBTGo offers a number of sample sequences, e.g. for automatically performing the various Bluetooth® RF test cases. The software allows a large number of graphical elements to be integrated into the measurement report and is thus a valuable tool in R&D and product verification.

## Remote compatibility between the R&S®CMU200 and the R&S®CBT/CBT32

All remote scripts generated for the R&S®CMU200 Bluetooth® signaling function group can also be used for the R&S®CBT and R&S®CBT32 without requiring any modifications. The only prerequisite is that the RF1 dual I/O or the RF2 dual I/O of the R&S®CMU200 must be used in the R&S®CMU200 remote script.

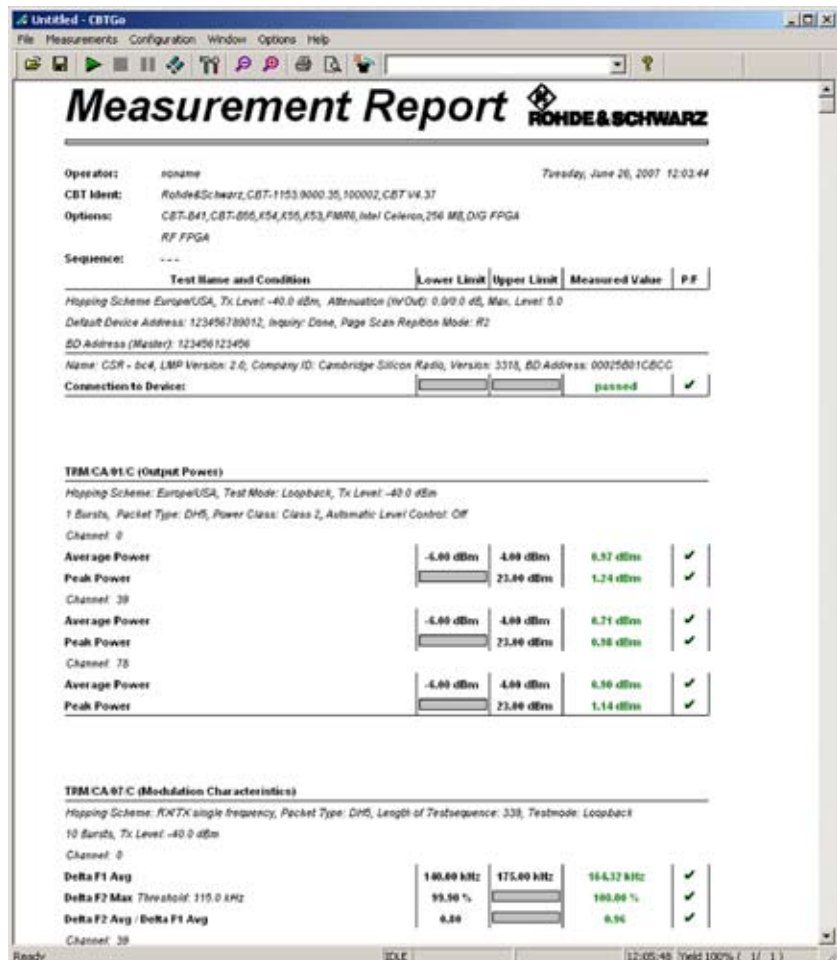



## Ordering information

Designation	Type	Order No.
Bluetooth® Tester with display, 4 HU	R&S® CBT	1153.9000.35
Bluetooth® Tester without display, 19", 2 HU, for remote control	R&S® CBT32	1153.9000.32
Hardware option for R&S® CBT: Dual-Channel Audio Generator and Analyzer	R&S® CBT-B41	1170.3406.05
Hardware option for R&S® CBT32: Dual-Channel Audio Generator and Analyzer	R&S® CBT-B41	1170.3406.02
Hardware option for R&S® CBT/CBT32: Digital Audio Interface (S/P-DIF; R&S® CBT-B41 required)	R&S® CBT-B42	1170.3706.03
Software option for R&S® CBT/CBT32: A2DP Stereo Profile and SBC Codec (R&S® CBT-B41 required)	R&S® CBT-K52	1170.4002.02
Software option for R&S® CBT/CBT32: Handsfree and Headset Profiles	R&S® CBT-K54	1170.3806.02
Software option for R&S® CBT/CBT32: Enhanced Data Rate (EDR)	R&S® CBT-K55	1170.3206.02
19" Adapter, 2 HU, for R&S® CBT32	R&S® ZZA-211	1096.3260.00
19" Adapter, 4 HU, for R&S® CBT	R&S® ZZA-S03	1105.6756.00
Documentation of Calibration Values	R&S® DCV-1	0240.2187.08
Antenna Coupler for Mobile Phones	R&S® CMU-Z10	1150.0801.10
RF Shielded Cover, extension for R&S® CMU-Z10	R&S® CMU-Z11	1150.1008.02
Bluetooth® Antenna, extension for R&S® CMU-Z10	R&S® CMU-Z12	1150.1043.02

The Bluetooth® word mark and logos are owned by the Bluetooth SIG, Inc. and any use of such marks by Rohde & Schwarz is under license.

*The R&S® CBT32 (bottom) is a cost-effective rack version of the R&S® CBT (top) featuring identical test capabilities and optimized for use in production*





For data sheet, see PD 0758.1287.22  
and [www.rohde-schwarz.com](http://www.rohde-schwarz.com)  
(search term: CBT, CBT32)



**ROHDE & SCHWARZ**

[www.rohde-schwarz.com](http://www.rohde-schwarz.com)

Europe: +49 1805 12 4242, [customersupport@rohde-schwarz.com](mailto:customersupport@rohde-schwarz.com)  
USA and Canada: +1-888-837-8772, [customer.support@rsa.rohde-schwarz.com](mailto:customer.support@rsa.rohde-schwarz.com)  
Asia: +65 65 130 488, [customersupport.asia@rohde-schwarz.com](mailto:customersupport.asia@rohde-schwarz.com)